



FIG 1 - AUSSIE MATE 580-AL INSTALLED HORIZONTALLY

AVM System – Aussie Mate 580-AL

DESCRIPTION

AVM Aussie Mate 580-AL is a UV stable, heavy duty 60 mil below-grade bituminous sheet waterproofing membrane and methane barrier with aluminum facer. AVM Aussie Mate 580-AL exhibits excellent adhesion,

elongation and recovery properties. Unlike other sheet membranes, Aussie Mate® 580-AL can be exposed to U.V. up to 180 days.

Specifications	Thickness	Packaging	Typ. Roll Weight
Aussie Mate 580-AL	60 mil	3.28 ft. x 65.6 ft.	85 lbs

APPLICATIONS

Vertical Walls: As a waterproofing membrane and/or methane barrier of concrete and masonry block walls.

Underslab: As a vapor barrier and/or methane barrier under concrete slabs.

Split-slab Plaza Decks: Waterproofing installed in-between two concrete slabs or over wood decks that will receive a topping slab. It may also be used as an under-tile membrane when a mud-bed or thick-set type assembly is required.

Planters: Waterproofing of planters and other earth covered structures.

DELIVERY, STORAGE, HANDLING

Delivery all AVM System 580-AL materials to the job site in their original sealed containers, with the manufacturer's name and label intact. Store at temperatures between 50°F and 90°F. Do not store materials in direct sunlight or where they may be damaged by water or rain. On the jobsite, if products will be exposed to the weather, AVM strongly recommends covering with a tarp or other protection. Failure to comply to recommended storage conditions may affect product performance and/or void the warranty.

APPROVALS

Aussie Mate 580-AL is approved by LARR (LARR #26138) for use as both a waterproofing membrane and/or methane barrier. This approval is based on tests and analysis in accordance with LADBS Acceptance Criteria L021 Below-Grade Exterior Damp-Proofing and Waterproofing Materials and L137 Methane Barrier Test Criteria.

ACCESSORY PRODUCTS

AVM Adhesive 501: low-VOC, quick-drying, solvent-based, high-tack contact adhesive.

AVM Primer 500: low-VOC water-based primer for bituminous and liquid rubber membranes.

Aussie Swell Red Waterstop: Active swelling concrete joint waterstop used around penetrations and applicable concrete joints.

Aussie Sealant M: Marine grade single component polyether sealant/adhesive. Used to adhere Aussie Swell Red Waterstop, around penetrations, and at terminations.

AVM Drain Board 6000: Drainage composite composed of a molded core profile core & a filter fabric. Used to remove hydrostatic presence in non-hydrostatic conditions. Can also improve substrate conditions.

AVM Bottom Drain: Thickened base drain composite designed to collect water from sheet drainage pales and then discharge water through collector pipes to collection system.

Aussie Tube: ½ in. wide permeable tube installed prior to concrete placement, with packers set at 25 ft. on center. Inject after concrete cure. Provide min. 2½ in. concrete cover on all sides. Stagger end laps of hose min. 2 in. Used in trouble areas and in cold joints as a waterstop.

Termination Bar: Extruded-aluminum or formed-stainless-steel bars with upper flange to receive sealant. Used to terminate membrane at grade or during transitions.

Spray Adhesive: Super 77 by 3M or approved equal. Environmentally friendly, spray adhesive for drainage panel filter fabric lap joints.

LIMITATIONS

Temperature: When installing below temperatures of 40° or lower, follow our cold weather recommendations.

UV Exposure: Install acceptable protection as soon as the membrane has been installed. Do not leave membrane exposed to UV for more than 180 days.

Green/Wet Concrete: May be applied to damp but not waterlogged surfaces (Green Concrete) with Adhesive 501 after 7 days.

SECTION 1 – GENERAL INSTALLATION GUIDELINES

1.1 – Substrate

Aussie Mate 580-AL may be placed on concrete, masonry block, steel or wood substrates. Substrates shall be sound, stable, clean, free of dirt, dust, oil, grease and curing agents.

Concrete Surfaces:

- Remove laitance, oil, grease, curing agents, debris and other deleterious materials from surfaces scheduled to receive application. On horizontal, older, or very dirty substrates, high pressure washing, or bead blasting are highly recommended. If needed, apply a thin parge coat using AVM Crete 6200.
- Concrete finish shall be finished with a smooth, light broom or sponge surface texture. Repair all concrete surface defects, spalls, or poorly consolidated concrete with a cementitious patching material
- Clean hairline or small cracks and rout out all cracks wider than 3/16 inch. Seal the large cracks flush with AVM Aussie Seal M Sealant.
- Fill in all gaps or cracks larger than 1/4" wide with a cement-based patching material and remove any sharp protrusions.
- On horizontal surfaces, verify that substrate provides adequate slope for proper drainage. (Minimum slope: 1/4" per foot)

Masonry Block Walls: All mortar joints shall be flush to the face of the masonry block. Remove any mortar clumps from the CMU wall.

1.2 – INSTALLATION: Priming, Laps and Corner Detailing

Priming: All concrete surfaces should be dry and have a minimum cure time of 3 days and can be primed with AVM Adhesive 501 or a parge coat of Aussie Membrane 500. AVM Adhesive 501 may be applied to damp but not waterlogged (green concrete) concrete after a curing time of 3 days. Install membrane when Adhesive 501 is dry to the touch. Primed surfaces must be covered with membrane the same day or must be re-primed.

Inside & Outside Corners: Pre-strip all inside and outside corners with an 8" wide piece of Aussie Mate 580-AL centered over the corner. Wall-to-deck joints and inside corners require a 45 degree 2" x 2" mortar or 3/4" Aussie Seal M cant strip prior to installing 8" Aussie Mate detail strip. See figure 1.1 for standard detailing.

Factory Lap: Minimum 2 1/2" overlap required. See **Figure 1.2** on the next page.

Non-Factory Lap: Minimum 2 1/2" overlap required. If in the water-table non-factory laps must be sealed with Aussie Seal M. See **Figure 1.3** on the next page.

*See section 4 for Methane & Vapor Barrier Instructions and Detailing

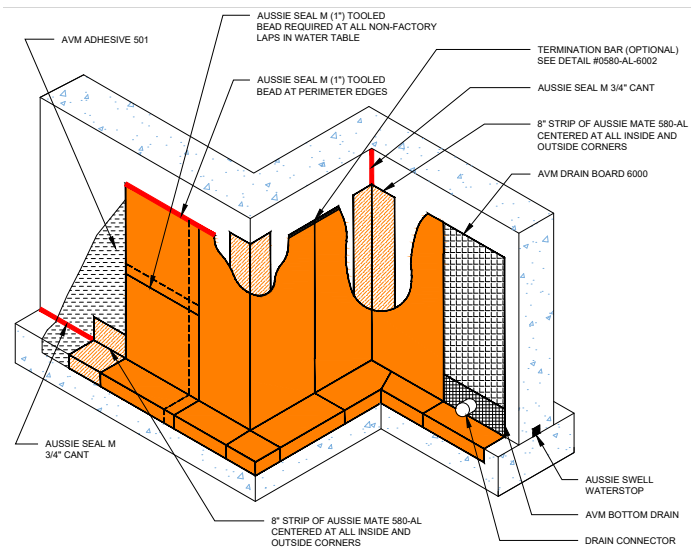

FIGURE 1.1 – STANDARD INSIDE, OUTSIDE & FOOTING DETAILING

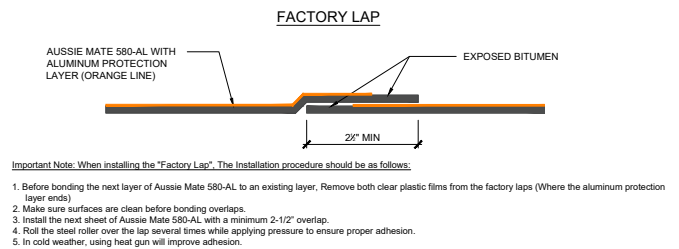

FIGURE 1.2 – STANDARD FACTORY LAP

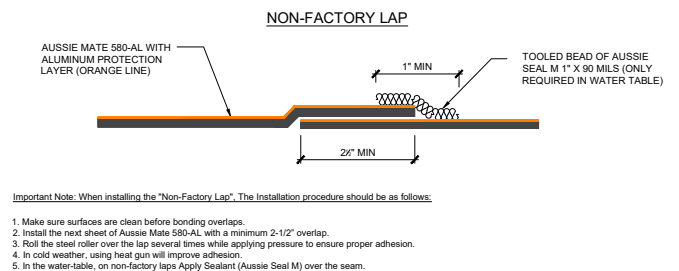

FIGURE 1.3 – NON-FACTORY LAP

Installation Instructions

Inside Corner: To further illustrate the above **Figure 1.1**, **Figure 1.4** will provide a step-by-step approach to doing an inside corner detail with the Aussie Mate 580-AL. The first step would be to install $\frac{3}{4}$ " cants of Aussie Seal M in all corners as well as Adhesive 501 on all surfaces. Take an 8" piece of 580-AL, cut and fold it to fit into the corner, A second piece of Aussie Mate 580-AL will be placed over the wall with less membrane as shown below. Finally, install Aussie Mate 580-AL into the corner and over the two pieces already in place.

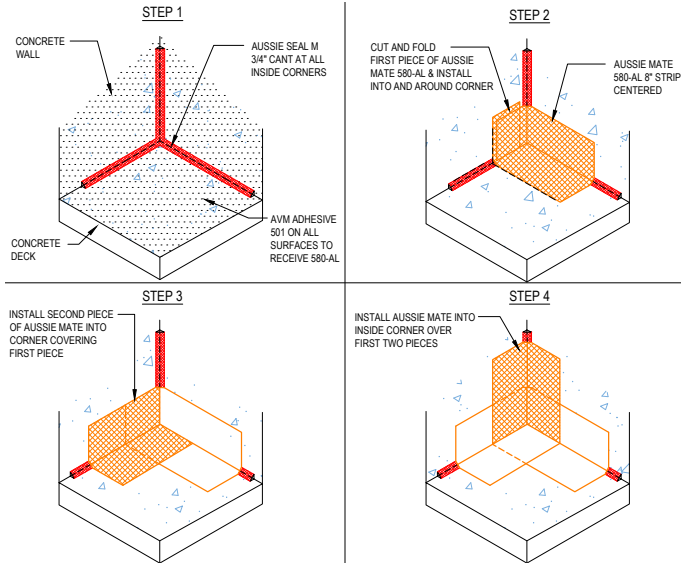

FIGURE 1.4 - INSIDE CORNER

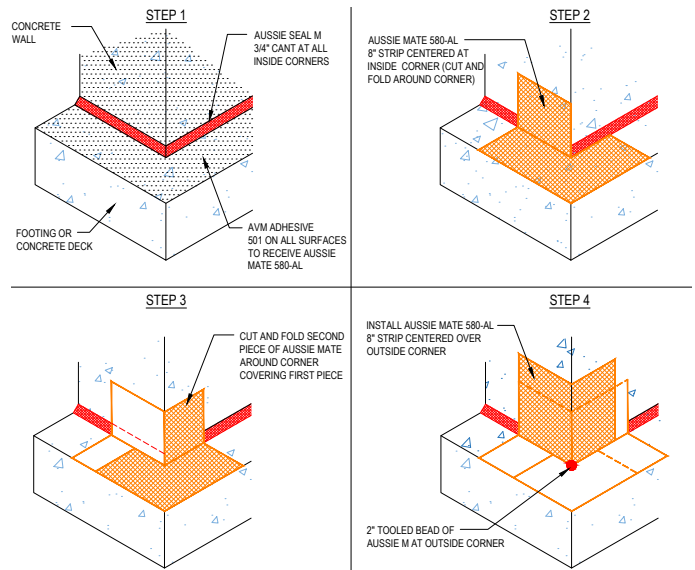

FIGURE 1.5 - OUTSIDE CORNER DETAIL

Before installing the membrane, prep the substrate and complete detailing at inside and outside corner transitions. Horizontal surfaces require a minimum slope of $\frac{1}{4}$ " per foot for proper drainage.

Outside Corner: As discussed above, the first step of creating the outside corner detail, is to install a $\frac{3}{4}$ " cant of Aussie Seal Mat all inside corners and place Adhesive 501 on all surfaces that will receive the Aussie Mate 580-AL installation. Take an 8" strip of Aussie Mate 580-AL and center it at the inside corner and cut and fold around the outside corner. Cut and fold a second piece of Aussie Mate 580-AL and place around corner covering the first piece. Finally, like the Inside Corner detail above, you would install an 8" strip of Aussie Mate 580-AL and center it over the outside corner. Place a 2" tooled bead of Aussie Seal M by the outside corner as well. This is shown in **Figure 1.5**.

1.3 - INSTALLATION: Transition from Underslab Waterproofing/Vapor Barrier to Aussie Mate

Aussie Mate 580-AL is installed up vertical foundation walls and then backfilled against which will be discussed in Section 1.2. It often ties into underslab waterproofing in hydrostatic conditions or a vapor barrier prior to being installed up a foundation wall. When vapor barriers are not used and the project conditions are designed with a non-hydrostatic intent, the installation of the Aussie Mate 580-AL will begin 6" down for the construction joint formed by the foundation slab and the foundation wall or 6" onto the footing. Ensure all substrate, priming and detailing has been completed as noted in the previous section. Remove plastic release liner from membrane and install with bitumen side against the concrete (aluminum side up) beginning at the low point and working up to create a shingled effect. Overlap all membrane edges a minimum of 2½". Start at base of wall working upwards to ensure water is shingled away from the wall. Avoid creases and bubbles as much as possible. Immediately thereafter, use a metal or rubber roller and aggressively roll the roller several times over the membrane to ensure full and proper contact and adhesion with the substrate. Continue applying additional membrane sheets as needed to cover the entire surface while overlapping all seams and endlaps a minimum 2½". The membrane should be sealed off at the bottom edge by a 1" X 90 mils bead of Aussie Seal M. AVM Drain Board 6000 or protection board must be installed prior to backfill. This installation is shown in **Figure 1.6**.

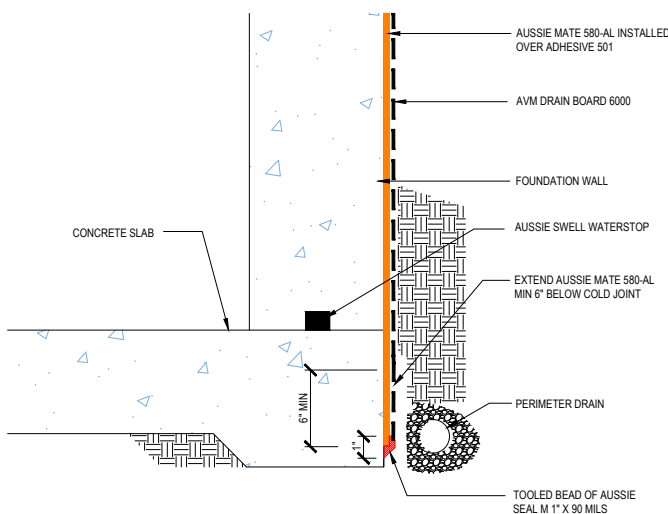

FIGURE 1.6 - FLUSH FOOTING

When tying into an underslab waterproofing at a flush slab, the Aussie Mate 580-AL should overlap a minimum of 6" over the underslab waterproofing membrane. The 1" X 90 mil bead of Aussie Seal M should seal the Aussie Mate bottom edge to the underslab waterproofing membrane. This is shown in **Figure 1.7** with AVM's Aussie Skin 550G/560G membrane.

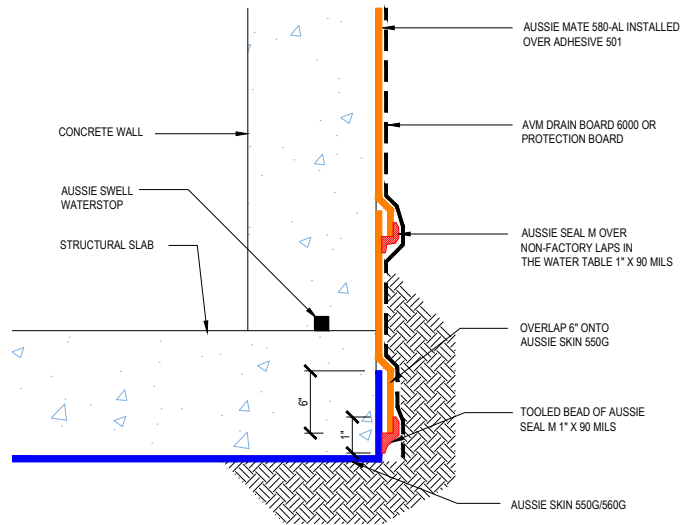

FIGURE 1.7 - FLUSH SLAB TIE-IN TO UNDERSLAB WATERPROOFING

When the tie-in is to a vapor barrier or Aussie Mate 580-AL installed underslab for methane and vapor mitigation (as discussed in Section 4) for flush slabs, there should be a vapor barrier/Aussie Mate 580-AL tail left over after the slab is poured to tie into the vertical Aussie Mate 580-AL. Seal the edge like shown in **Figure 1.6** above. Take the vapor barrier and lap it over the sealed membrane a minimum of 6". Then tape the top edge of the vapor barrier onto the Aussie Mate 580-AL. This can be seen in **Figure 1.8**. Keep in mind that the vapor barrier is per project design. The figures in this section will show Aussie Mate 580-AL underslab as the vapor barrier

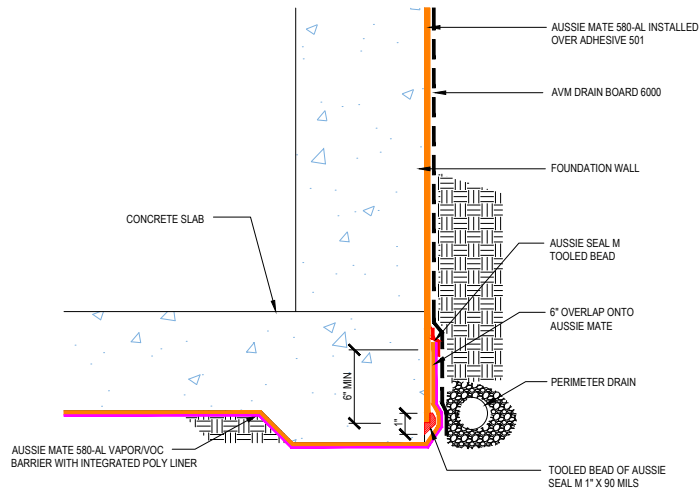

FIGURE 1.8 - FLUSH SLAB TIE-IN TO VAPOR BARRIER

For raised slabs, the same tie-ins would apply. If the vapor barrier or waterproofing does not wrap the footing then the Aussie Mate 580 would not need to tie into it. There will need to be an 8" strip of Aussie Mate 580-AL centered on a 3/4" cant of Aussie Seal M over the corner where the foundation wall meets the footing as described in the section prior. This is shown in Figure 1.9 below.

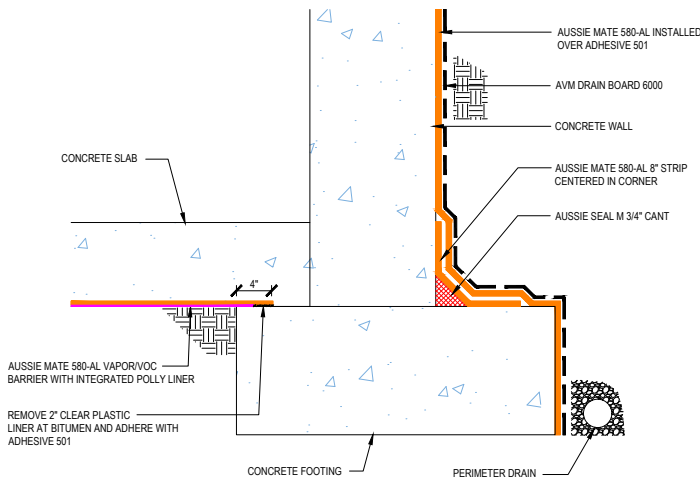

FIGURE 1.9 - VAPOR BARRIER

1.4- INSTALLATION: Elevator Pit

As with all installation with the Aussie Mate 580-AL, the first step is to prep the substrate. The overall installation of the Aussie Mate 580-AL will look very similar to the figures above when it comes to installation at the elevator pit. See Figure 1.10 to see how the installation is done as it ties into AVM's Aussie Skin 550G/560G membrane under the elevator pit.

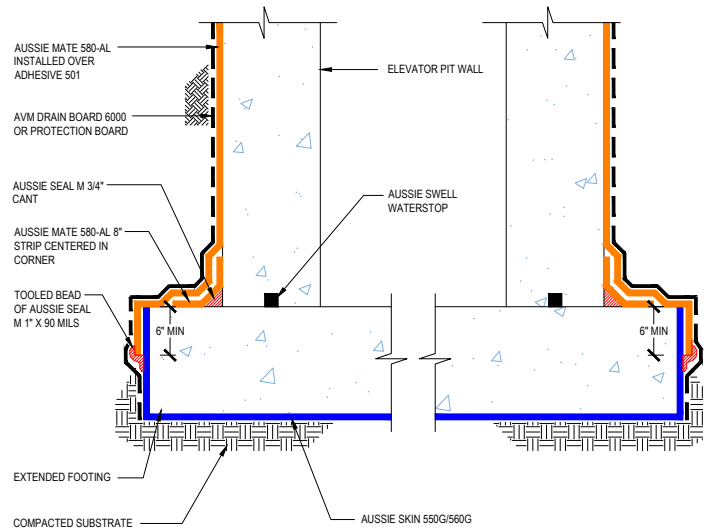

FIGURE 1.10 - ELEVATOR PIT

SECTION 2 - BACKFILL FOUNDATION WALLS

Properly prepare substrate as mentioned in the previous sections. Use AVM Adhesive 501 on the substrate surface. Remove plastic release liner from membrane and install with bitumen side against the concrete (aluminum side up) beginning at the low point and working up to create a shingled effect. Overlap all membrane edges a minimum of 2½". Start at base of wall working upwards to ensure water is shingled away from the wall. Avoid creases and bubbles as much as possible. Immediately thereafter, use a metal or rubber roller and aggressively roll the roller several times over the membrane to ensure full and proper contact and adhesion with the substrate. Continue applying additional membrane sheets as needed to cover the entire surface while overlapping all seams and endlaps a minimum 2½". Apply a bead of Aussie Seal M at all membrane terminations at the end of each day.

2.1 - INSTALLATION: Penetrations

Cut the Aussie Mate 580-AL to fit tightly around the penetration with no gaps larger than ½". If membrane cannot fit tight to the pipe a target sheet may be installed prior to field sheet. The target sheet should be placed a minimum of 4" around the perimeter of the pipe penetration being detailed. Place Aussie Seal M around the pipe extending 2" onto the membrane and 2" up the pipe with a ¾" fillet at the base of the pipe. An Aussie Swell Red Waterstop will be placed around the penetration prior to concrete coverage with a minimum of 3" of concrete coverage. A standard pipe penetration will be displayed in **Figure 2.1**.

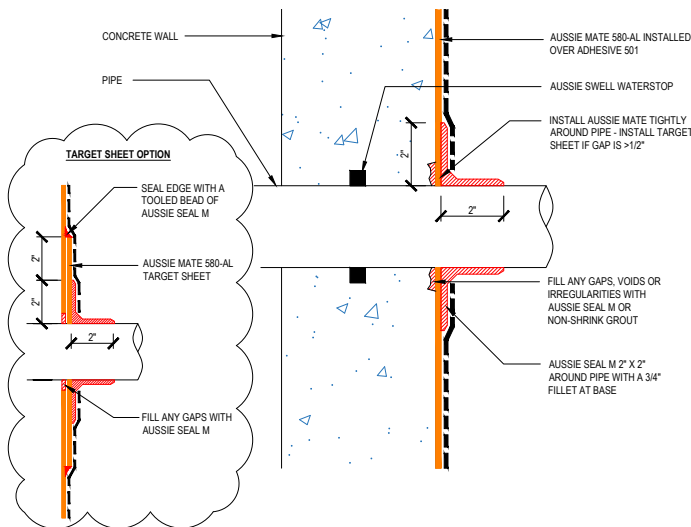

FIGURE 2.1 - TYPICAL PIPE PENETRATION

When there are multiple pipe penetrations alongside one another that need to be detailed, the guidelines will mimic the standard pipe penetration detail above so long as there is a 6" minimum clearance between the pipes. Please see **Figure 2.2** for this detail. When pipe penetrations do not meet the required 6" clearance between one another, please refer to you local AVM Sales Representative or the AVM Technical Team for detailing instructions.

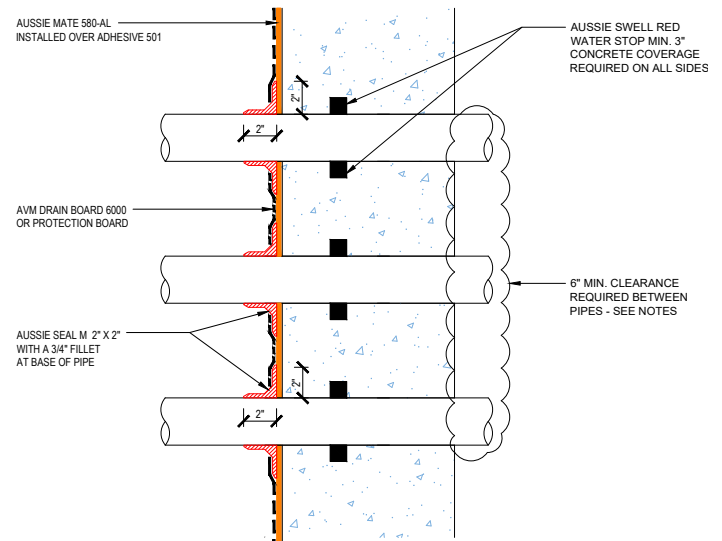

FIGURE 2.2 - MULTIPLE PIPE PENETRATIONS

Cored and sleeved pipe penetrations are also done in a very similar manner. Both will require a link seal and the space between the pipe and wall filled with a non-shrink grout. See **Figures 2.3 & 2.4**.

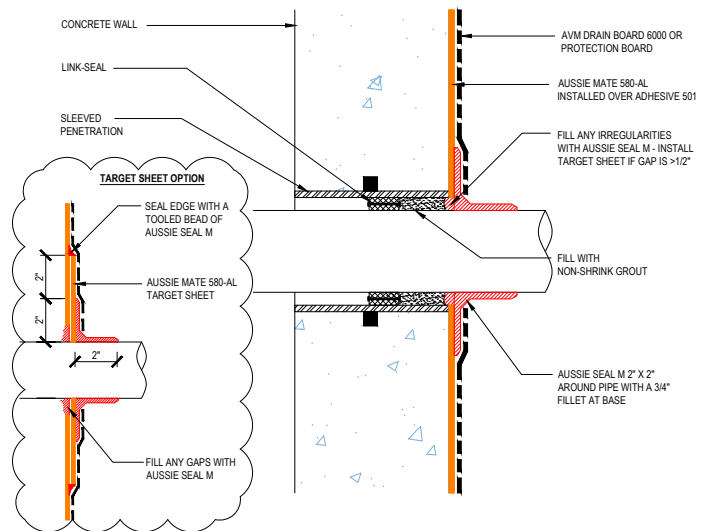

FIGURE 2.3 - SLEEVED PIPE PENETRATION

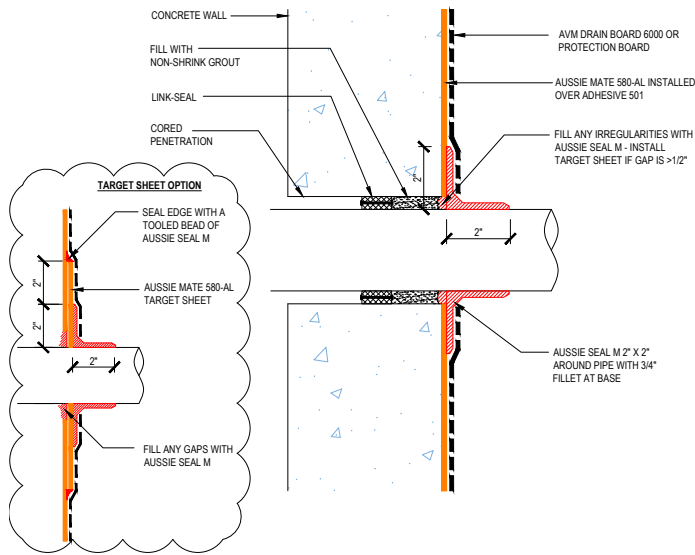

FIGURE 2.4 - CORED PIPE PENETRATION

2.2 - INSTALLATION: Grade Terminations

Terminate the membrane at grade level to ensure water cannot bypass the waterproofing. Firmly roll membrane edge and verify full adhesion to the concrete. Secure membrane edge with a fastened termination bar and seal with a tooled bead of Aussie Seal M. Exposed membrane above grade shall be covered with flashing or architectural finish to prevent long term exposure to sunlight. Membrane should be covered with AVM Drainboard 6000 or a protection course prior to backfill. Figure 2.5 will show the different types of terminations.

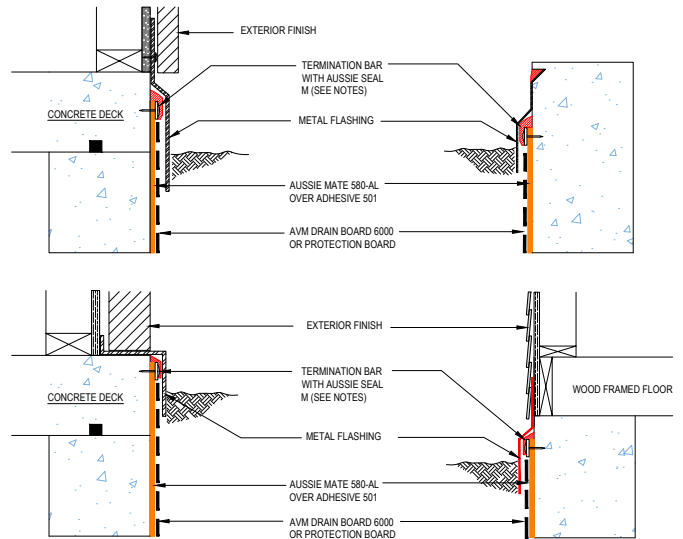

FIGURE 2.5 - GRADE TERMINATION OPTIONS

SECTION 3 – HORIZONTAL/PLANTAR INSTALLATION

Aussie Mate 580-AL can be installed above grade as a plantar/deck membrane in horizontal applications as well.

3.1 - INSTALLATION: General Installation

As with any installation with the Aussie Mate 580-AL, the substrate needs to be prepped and finished prior to installation. The AVM Adhesive 501 should be used on all surfaces as well. The horizontal deck should slope to the drain a minimum of 1/4" per foot to ensure water is drained. When installing the Aussie Mate 580-AL, remove the release liner along the membrane edge and ensure overlaps are a minimum of 2 1/2" with all end laps staggered 12". Firmly press the membrane onto the substrate and use a roller to ensure there isn't any creases or air bubbles on the membrane. Apply a bead of Aussie Seal M at the membrane edges when work is completed for the day to keep any site water from getting between the membrane and the substrate. Install AVM Drain Board 6000 or protection board over the membrane prior to placing overburden. Use AVM Drain Board 9000 for topping slabs designed for vehicular traffic. **Figure 3.1** shows the general overlaps for horizontal deck installation.

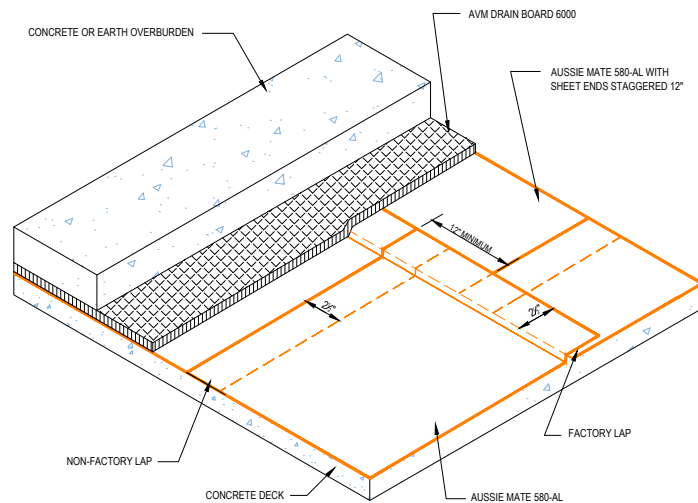

FIGURE 3.1 - OVERLAP AND SPACING FOR AUSSIE MATE 580-AL

Always inspect the Aussie Mate 580-AL for tears, blisters and unsealed seams prior to installing any overburden or protective course. When there are areas of membrane that are not adhered or damaged, remove that section of membrane and repair by placing a membrane patch that extends 6" around the perimeter of the existing, fully adhered membrane.

If flood testing is required for the project, allow a minimum of 24 hours of cure time for the Aussie Mate 580-AL prior to placing the standard 2" of water over the membrane. Record and repair any areas that leak prior to installing the overburden or topping slab.

3.2 - INSTALLATION: PIPE & DRAIN PENETRATIONS

Just like discussed in Section 2.2, to detail around a pipe penetration on the deck, cut the Aussie Mate 580-AL to fit tightly around the penetration with no gaps larger than 1/2". If membrane cannot fit tight to the pipe a target sheet may be installed prior to field sheet. The target sheet will extend 4" around the perimeter of the pipe penetration over the field sheet. Place Aussie Seal M around the pipe extending 2" onto the membrane and 2" up the pipe with a 3/4" fillet at the base of the pipe. **Figure 3.2** shows this done.

Figure 3.2 shows this done.

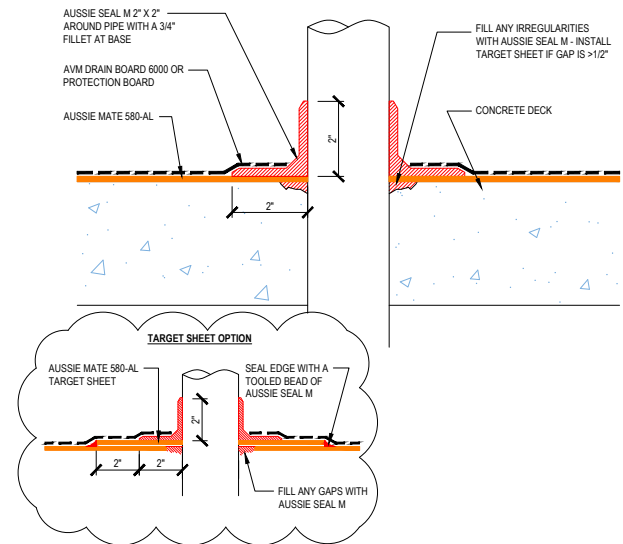

FIGURE 3.2 - DECK PIPE PENETRATION

Deck drains require placement of a target sheet that extends 4" around the drain to be placed over Adhesive 501. A field sheet of Aussie Mate 580-AL is then placed over the target sheet and wrapped tightly around the drain with the clamping ring of the drain installed through the both the field and the target sheet. The below **Figures 3.3, 3.4, & 3.5** show the various styles of drain all done this way.

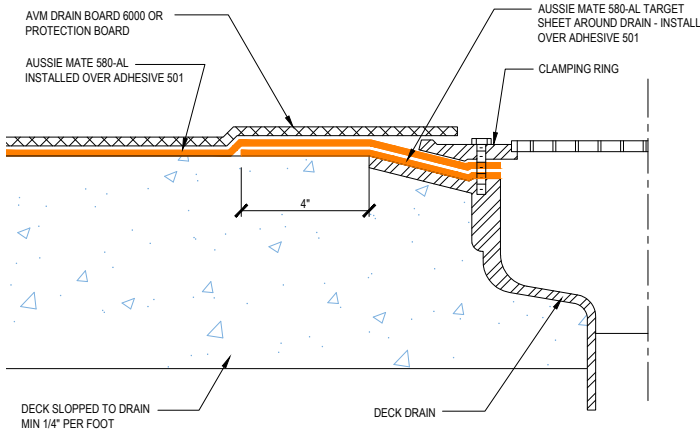

FIGURE 3.3 - DECK DRAIN FLUSH

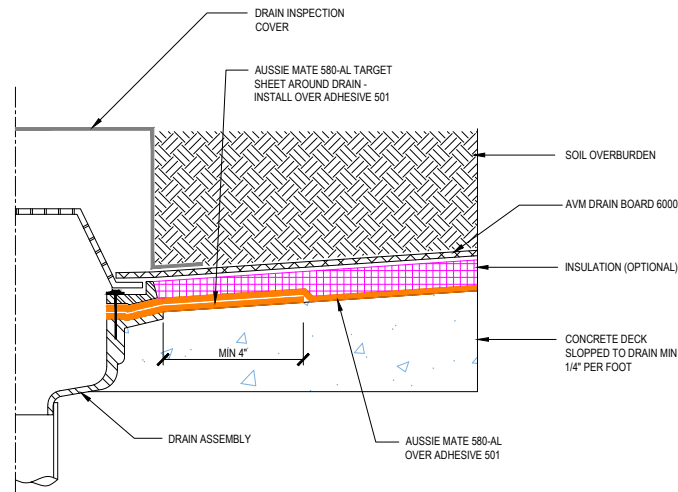

FIGURE 3.4 - DECK DRAIN WITH INSPECTION COVER

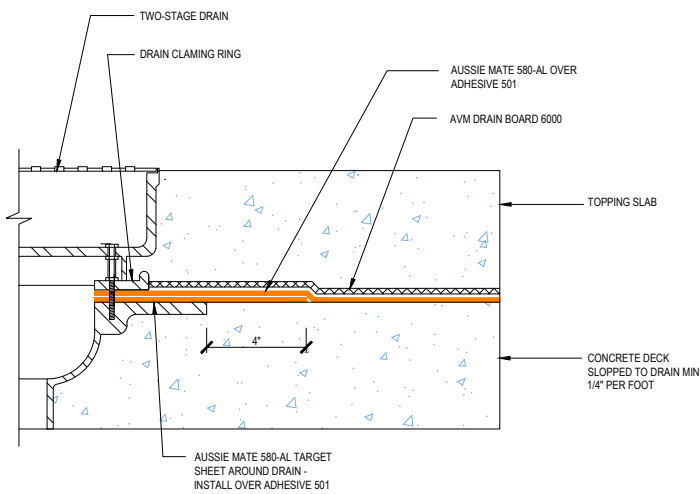

FIGURE 3.5 - SPLIT SLAB TWO-STAGE DRAIN

3.3 - INSTALLATION: Transitions and Planter Terminations

When the installation of the Aussie Mate 580-AL moves toward the perimeter of the building or close to a parapet wall, the membrane will need to transition up the wall and terminate. This is done very similarly to what the inside corner detail from the previous section looks like. First off, as with all installation, the substrate needs to be prepped, cured and the Adhesive 501 should be installed. From here, a 3/4" cant of Aussie Seal M would be placed at the corner. Then an 8" Aussie Mate 580-AL sheet is centered over the corner with 4" going up the wall and 4" extending out onto the deck. From there, the field sheet would overlap the strip and up the wall. A bead of Aussie Seal M would be tooled over a term bar or the perimeter edge of the membrane when the membrane has reached its termination point. Metal flashing is then lapped over the membrane preventing any possible UV exposure. See Figures 3.6 & 3.7

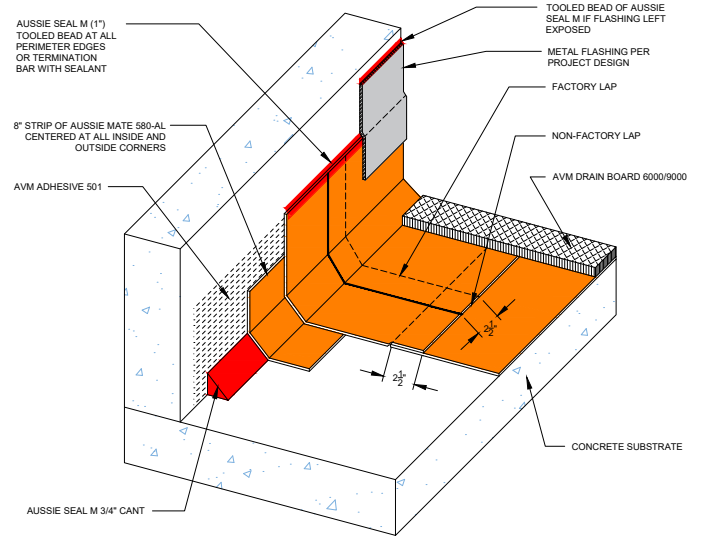

FIGURE 3.6 - DECK TO WALL TRANSITION

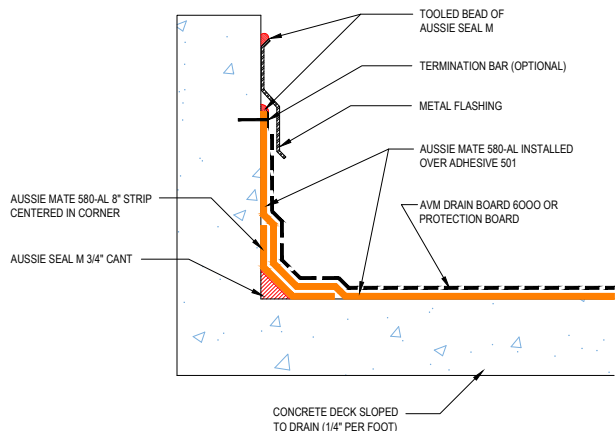

FIGURE 3.7 - DECK TO WALL TRANSITION

Installation Instructions

While the above figures show a standard termination, there are other things to consider. What goes above the termination (designed by others) could impact the way the membrane is terminated. See **Figure 3.8** for additional options.

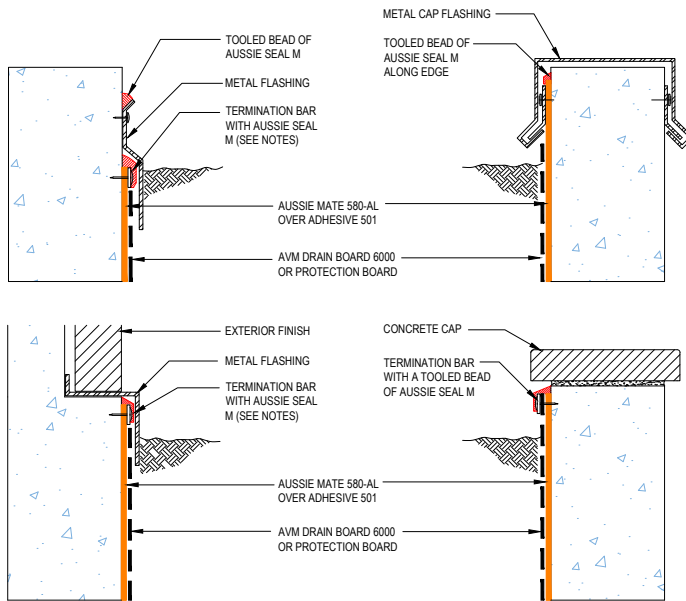

FIGURE 3.8 - ADDITIONAL TERMINATION OPTIONS

When there is nothing to turn up like in a split slab edge termination, you place an Aussie Mate 580-AL strip at the slab edge. The strip should be long enough that it extends a minimum of 6" past the metal flashing that will be placed over it and down the structural deck. Fasteners will be placed through the metal flashing and the strip of Aussie Mater 580-AL to hold them in place. Finally, the Aussie Mate 580-AL field sheet will run over the flashing and the strip to the slab edge. See **Figure 3.9** for this kind of split slab edge termination.

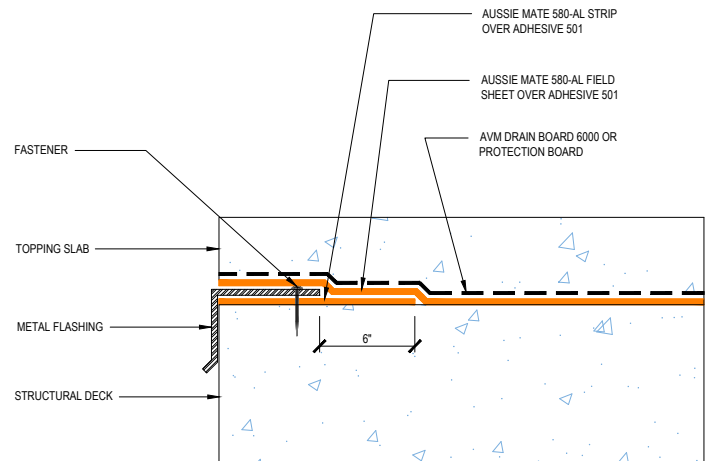

FIGURE 3.9 - SPLIT SLAB TERMINATION

SECTION 4 – METHANE/GAS VENTILATION

Aussie Mate 580-AL is an LARR approved methane and vapor barrier that can also be installed underslab for the sole purpose to mitigate vapors and methane. When installed underslab, the Aussie Mate 580-AL no longer qualifies as a waterproofing membrane. Unlike the previous sections, the installation for the underslab vapor mitigation applications will differ. The release liner will remain on the membrane as opposed to being removed as mentioned in the previous sections. Also, the overlap requirement will only be 2" as opposed to the 2½" also mentioned in the previous sections. **Figure 4.1** shows standard overlaps for methane mitigation underslab and goes through the step by step approach for Factory and Non-Factory laps.

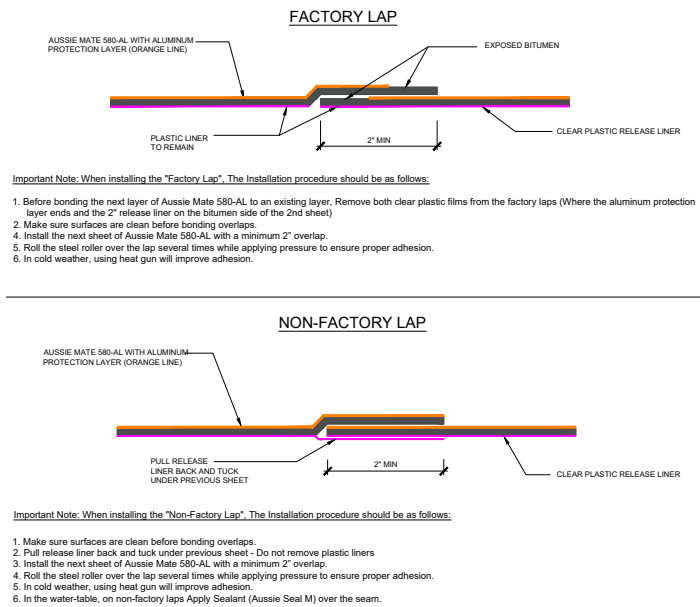

FIGURE 4.1 – FACTORY AND NON-FACTORY METHANE LAPS

To further illustrate this being installed, the below **Figures 4.2 & 4.3**, show the installation from an isometric perspective. 4.3 will show the use of the AVM GPL-16 Poly Liner which will be recommended when there are severely high levels of oil contaminates. Consult with a methane engineer for membrane protection requirements.

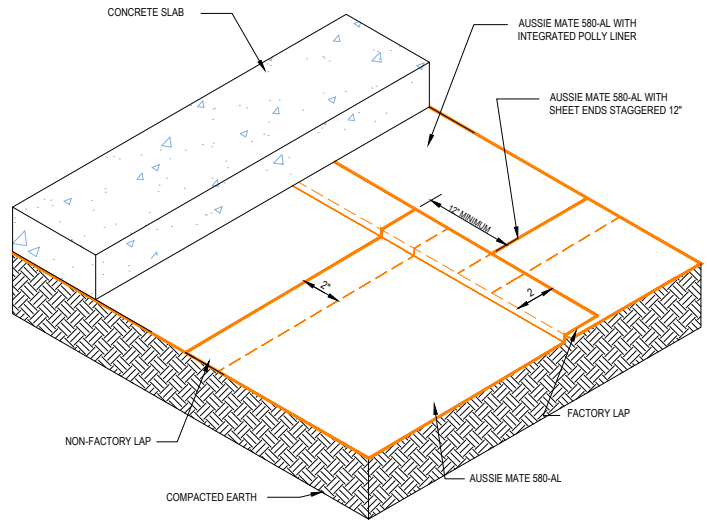

FIGURE 4.2 – ISOMETRIC VIEW OF UNDERSLAB Aussie Mate 580-AL ASSEMBLY

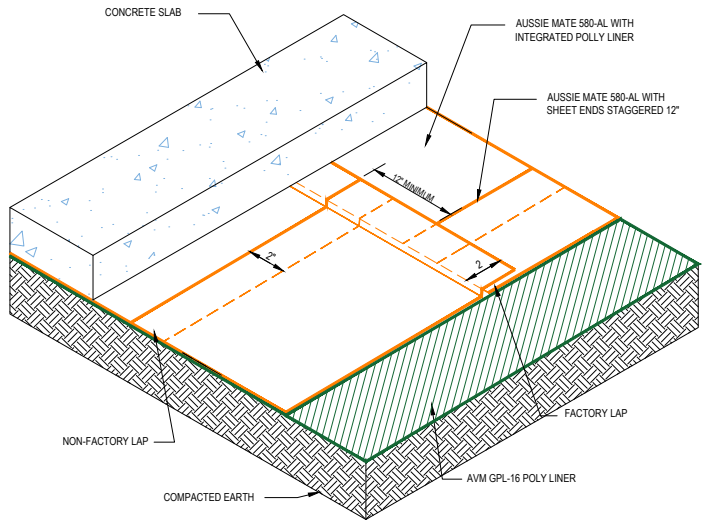

FIGURE 4.3 – USE OF GPL-16 POLY LINER FOR CONTAMINATED SITE

AVM Aussie DV: The AVM Aussie DV is an accessory product that is specifically used for gas ventilation. It is a modular gas collection system consisting of a 3-D, high-flow, venting core which is wrapped with a non-woven filter fabric. It also includes special connectors for use in conjunction with active/passive gas venting system. It is installed directly on the sub-grade eliminating trenching. It has a larger opening area per linear foot compared to pipe allowing for higher ventilation efficiency. It is also placed closer to the vapor barrier for more effective venting. The Vent layout in the foundation slab is shown below in **Figure 4.4**. Spacing can vary depending on project specific design and contamination levels.

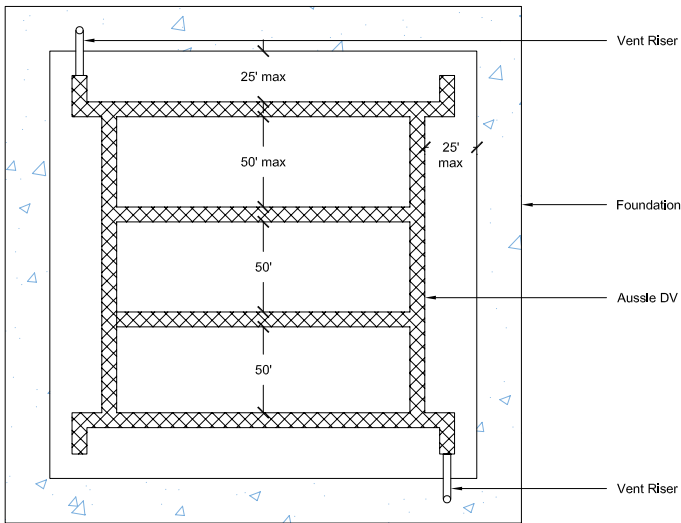

FIGURE 4.4 - AUSSIE DV VENT LAYOUT- PLAN VIEW

As the Aussie DV is positioned below the slab, the Aussie Mate 580-AL would be installed underslab as well. The Aussie DV is connected to vent riser PVC pipes that vent the vapor/gas. The result of the Aussie DV Vent Layout plan will be that some of the PVC vent risers will need to go through the membrane in certain locations. Details of these pipes will be very similar to how they are done in the other applications of the Aussie Mate 580-AL. **Figures 4.5 & 4.6** on the next page will show these penetrations through the membrane underslab.

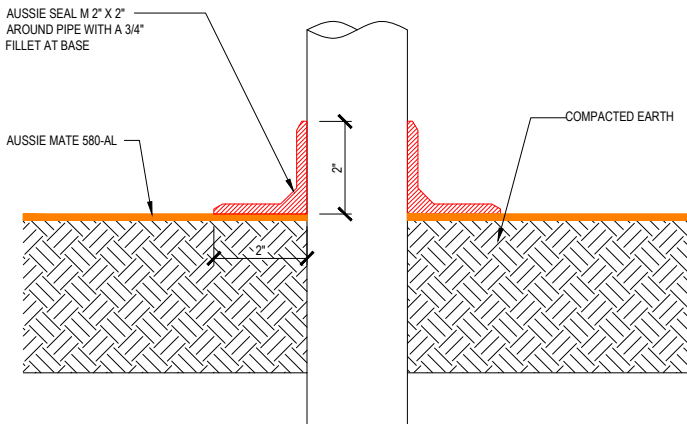

FIGURE 4.5 - VERTICAL PIPE PENETRATION

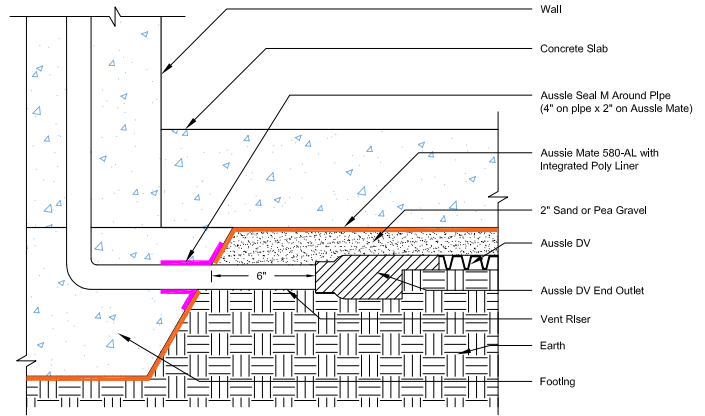

FIGURE 4.6 - DV CONNECTION

To better understand the sequencing and the assembly of the ventilation system with the Aussie Mate 580-AL, please reference the below diagram **Figure 4.7**. The Aussie DV System is installed in the Drain Rock or Pea Gravel. The Aussie DV System ties into a vent riser either through the slab or through the wall to properly ventilate the vapor from below grade. The Aussie Mate 580-AL would then be installed over the gravel/rock with penetrations being detailed per the above figures. The slab would finally be poured over. Consult Methane Engineer for membrane protection.

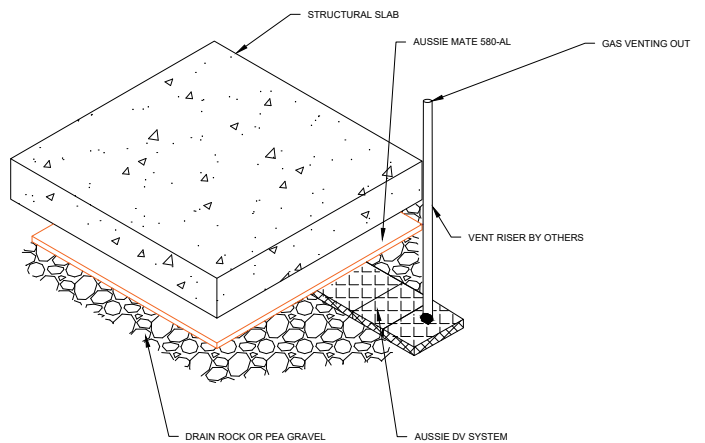

FIGURE 4.7 - ISOMETRIC VIEW OF VENT ASSEMBLY

COLD WEATHER (20-40°) INSTALLATION

In colder temperatures, adhesives and sealants don't bond as well due to the temperatures causing reduced adhesion strength. During these conditions, additional procedures may be required to ensure proper bonding and performance.

1. Make sure to keep all Aussie Mate 580-AL, accessories and sealant warm (approx. 70°F) A warm room or tent work well. This allows the bitumen to remain flexible when rolling out.
2. AVM Adhesive 501 should be kept in heated area just prior to use. This maintains workability and prevent it from freezing
3. Optionally can run a Leister heat welding machine (or a similar heat welding machine) over the seams as follows:
 - a. Use Leister Model Verimat 2 or a similar heat welding machine
 - b. Set Temperature to its lowest setting
 - c. Run the machine at a comfortable pace (optionally can run it at the top speed)
 - d. Check for proper adhesion once installed.
4. Blow hot air over them while rolling the pressure roller over them to improve adhesion. Check for proper adhesion once installed.
5. Applying the sealant in cold weather (20°F - 50°F) keep the sealant warm prior to use. Apply the sealant while still warm. If needed, use a heat gun to blow hot air to pre-heat the substrates. Check for proper adhesion once installed. Sealant should be allowed to fully cure before exposed to hydrostatic pressures. In very cold weather this may take 14+ days. Therefore, make sure to keep dewatering systems active for a minimum 30 days after sealant installations.



LEISTER HEAT WELDER

PROTECTING THE MEMBRANE

The membrane is often exposed to environmental and construction traffic, so it is important to protect the membrane during construction until the placement of concrete.

1. Use only water-based marking chalk on top of the installed waterproofing membrane. If other construction marking products are intended to be used, they must be reviewed and approved in writing by the waterproofing manufacturer.
2. Protect membrane during concrete placement from overspray with polyethylene sheeting or other approved means. Remove contamination and cured overspray material from membrane with mechanical means, taking extra care to not damage the waterproofing, prior to further placement of adjoining concrete.
3. Do not permit vehicular traffic on unprotected membrane.
4. Inspect for damage just prior to placement of concrete and make repairs in accordance with manufacturer's recommendations.
5. Product may not be exposed to sunlight for longer than 60 days. If exposure duration is approached and/or exceeded contact manufacturer representative for repair and/or replacement recommendations.

System Specifications

Test method: LARR LO21

Descriptions	Standard	Requirement	Test Results	Pass/Fail
Water Vapor Permeance	ASTM E 96 water method	≤ 1	0.01 Perms	Pass
Resistance to Decay		Report Results	0.01 Perms	Pass
Samples Tested:	ASTM 154 / ASTM E 96 water method	≤ 10	% Change/Perms: 0%	Pass
Field Area, Factory Lap, Non-Factory Lap		≤ 10	% Weight Loss: 0%	Pass
Tension and Elongation (MD) % Elongation	ASTM D 2523 (Tested Bitumen w/Aluminum)	≥ 25	68 %	Pass
Tension and Elongation (CMD) % Elongation	ASTM D 2523 (Tested Bitumen w/Aluminum)	≥ 25	65 %	Pass
Tension and Elongation (Bitumen only)	ASTM D 2523	≥ 300%	Report Results	Pass
Adhesion to Concrete/Masonry (lbf/in.)	ASTM D 903	≥ 5	Pass	Pass
Puncture Resistance (lbf)	ASTM E 154	≥ 80	125 lbf	Pass
Hydrostatic Pressure resistance max (PSI)	ASTM D 5385	Report Results	100	Pass
Hydrostatic Pressure resistance max (ft of water)	ASTM D 5385	Report Results	231 ft of water	Pass
Hydrostatic Pressure Resistance (ft of water)	ASTM 751	Report Results	171 ft of water	Pass
Low Temperature Flexibility (MD) -20F°	ASTM D 5147	Pass or Fail	Pass	Pass
Low Temperature Flexibility (CMD) -20°	ASTM D 5147	Pass or Fail	Pass	Pass
Tensile Strength	ASTM D 412	Report Results	540 PSI	Pass
Bonded Seam Strength	ASTM D 882	Report Results	46 lbf	Pass
Methane Gas Transmission Rate (mL/day*m ² *atm)	ASTM D4068 Anex A/D412	≤ 40	0.5	Pass
Microorganism Resistance (Soil Burial)	ASTM D4068 Anex A/D412	Pass or Fail	Pass	Pass
Oil Resistance Test	ASTM D543 / D412	Pass or Fail	Pass	Pass
Heat Aging	ASTM D 412	Pass or Fail	Pass	Pass
PCE Diffusion Coefficient	ASTM 96/96M-16	Report Results	2.26e-15m ² /s	Pass
TCE Diffusion Coefficient	ASTM 96/96M-16	Report Results	4.58e-15m ² /s	Pass
Benzene Diffusion Coefficient	ASTM 96/96M-16	Report Results	6.3e-15m ² /s	Pass

*AVM considers this product to be a VOC barrier based on the above test results.
Please contact AVM Technical Services if you have further questions regarding specific VOC's

Item/Component	Packaging	Approx Shipping Weights	Qty per Pallet	VOC
Aussie Mate 580-AL 80-mil	3.28'x65.6' Roll (215 sq.ft.)	123.2 Pounds (56 Kg) / Roll	16 Rolls/Pallet	N/A